

1. Calculate the area of this shape.

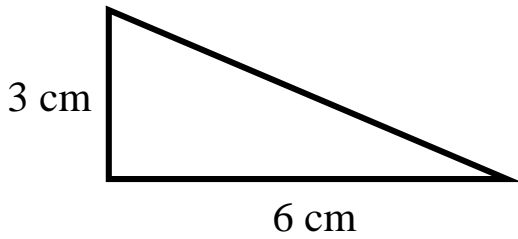

.....
(2 marks)

2. Calculate the area of this shape.

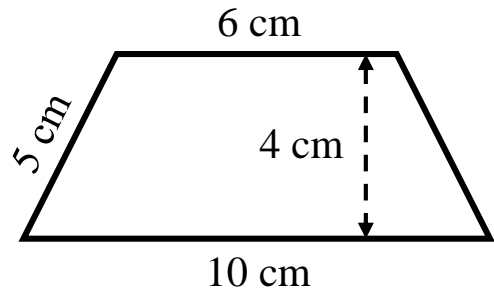

.....
(2 marks)

3. Calculate the volume and surface area of the cube below.

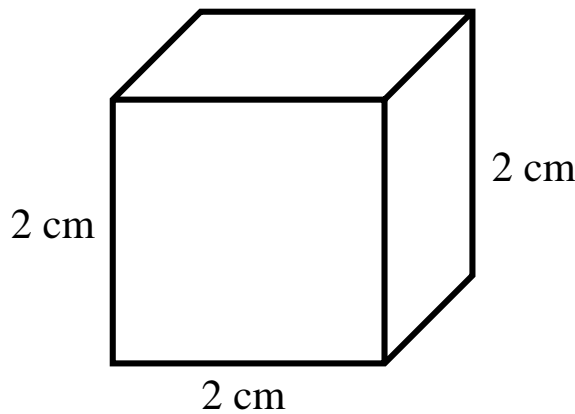

Volume =

Surface area =
(5 marks)

3. Calculate the area of this circle.

Leave your answer in terms of π .

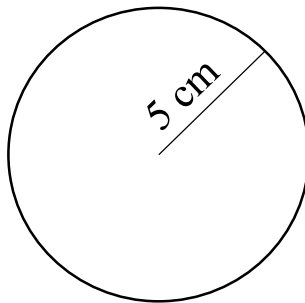

.....
(2 marks)

4. Is it possible to make a right angle triangle with sides of 3cm, 4cm and 5cm.

.....
(2 marks)

5. Reflect shape A in the line x axis

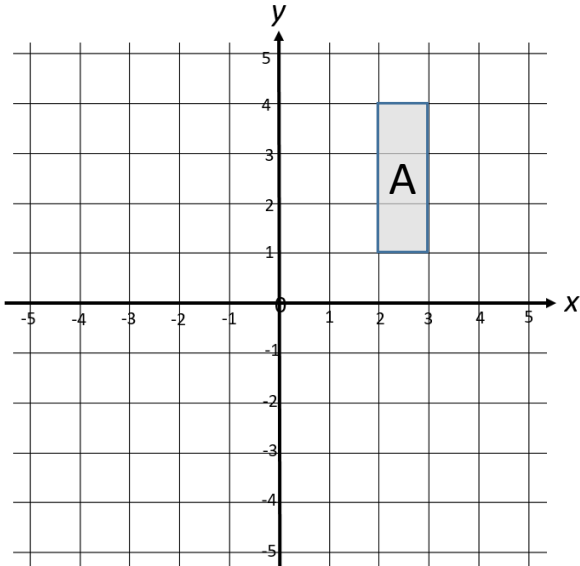

(2 marks)

6. Translate shape B by the vector $\begin{pmatrix} 5 \\ 2 \end{pmatrix}$

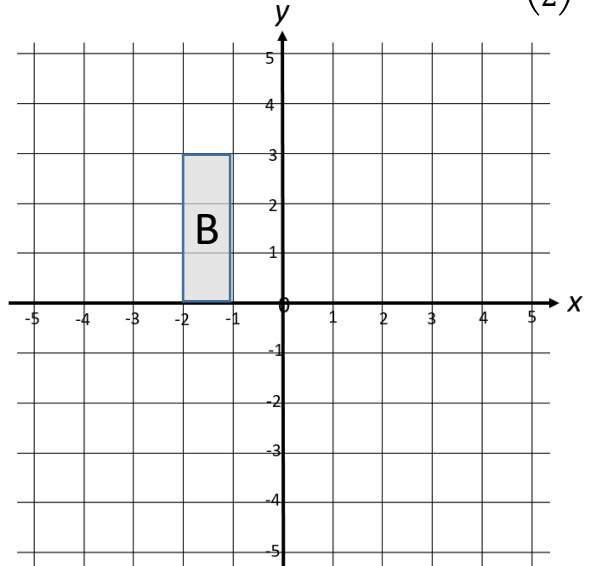

(2 marks)

7. Describe the single transformation from shape A to B.

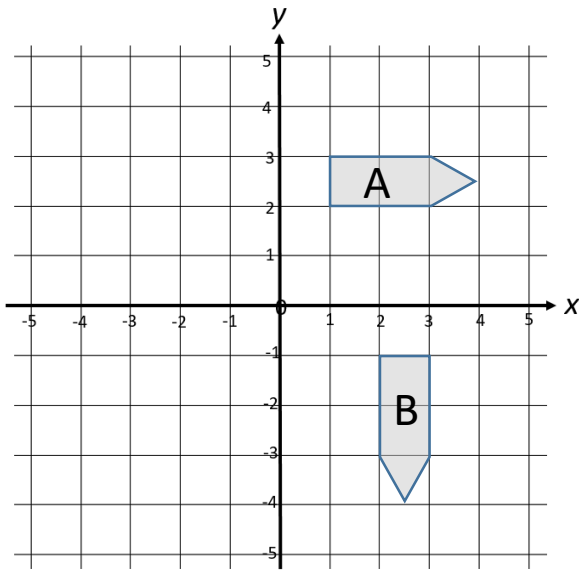

(2 marks)

8. Enlarge shape A by scale factor 2 from the center $(0, 0)$

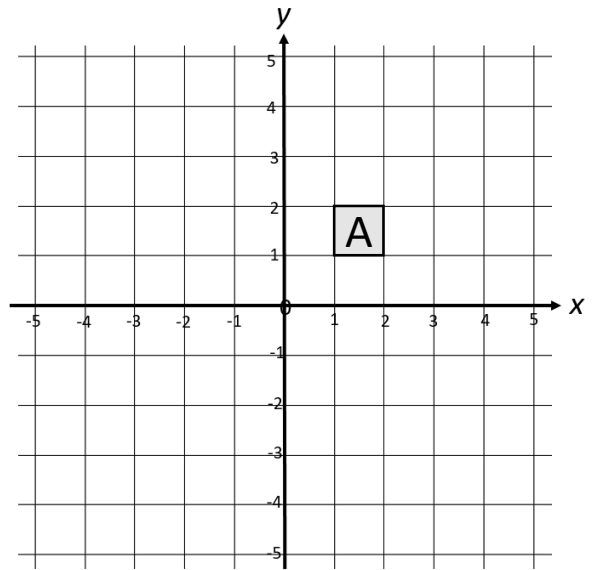

(2 marks)

Score =